

The ST-65A is a desktop microphone stand, and the stand shaft of two sections is provided. The upper shaft can be freely raised and lowered from 120 mm to 175 mm in height. The unit is supplied with the clip type microphone holder allowing to hold the microphone body by 35 mm in maximum diameter.



Order no: ST-65A

Specifications

Weight	1,0 kg
Gross weight	1,1 kg
Finish	semi-gloss, paint, black

Appearance

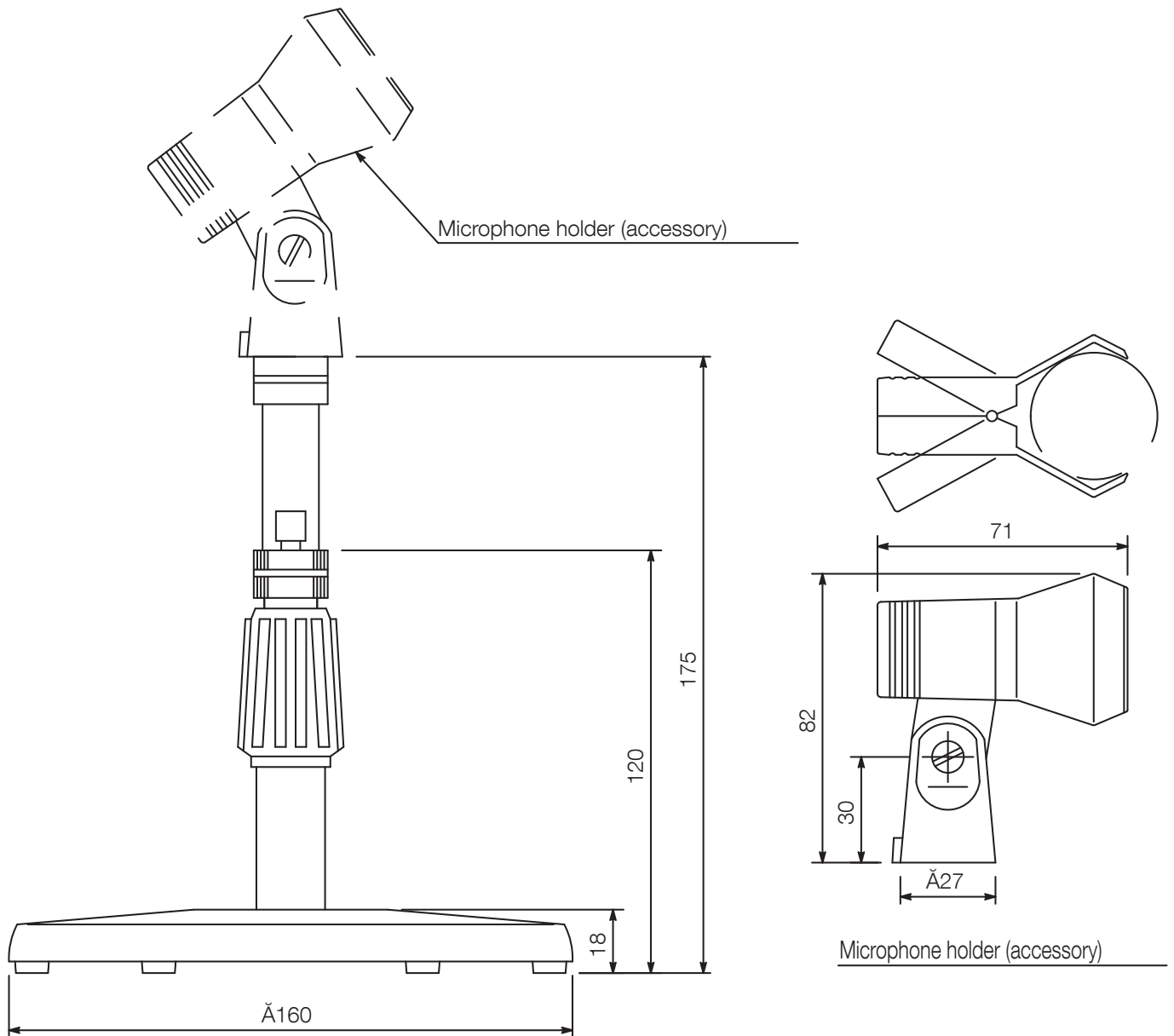

UNIT:mm SCALE:1/2