

VELO

MERRYFAIR®

Seating Products



Seating Excellence at Work

The Velo product family offer four models in the range to meet different needs and budgets in a workplace.



Backrest Height

Medium backrest with headrest, medium backrest and low backrest. All comes with our charcoal color back cover.

Armrest

Standard or soft PU foam pad with three dimensionally adjustable or non adjustable fixed armrest.

Type of Upholstery

Seat and backrest covered in leather or synthetic covering for premium model or seat covered with fabric and backrest covered with the mesh fabric for standard model.

Mechanism

Standard advanced Synchro mechanism provides Side Tilt tension control, multi- position Tilt lock, and pneumatic seat height control.



Velo offers three backrest heights, two types armrests and two types of upholstery.

Headrest

Fixed Cushion Headrest, consists of 38mm extra soft sponge to give optimal support to the user.

Polyester Mesh

Provides elastic support, yet allowing ventilation for airy comfort.

Armrest

Come with 4-way armrest adjustable for height, width, depth and swivel angle. Armrest in black, of molded polyurethane with steel insert. The fixed armrest molded by black polypropylene (100% recyclable).

Base

350mm Five-strong base of diecast aluminium alloy (100% recyclable) in polished finish. 50mm dual-wheel castors of moulded polyamide (nylon).



Backrest

Black outer shell, grey inner shell, supported by a aluminium backbone in polished finished. The back frame made by black polypropylene (100% recyclable)

Mechanism

Advanced Synchro mechanism provides Side Tilt tension control, multi-position Tilt lock, and pneumatic seat height control. The movement of the seat and the backrest are coordinated and correspond to body movements. The tilt tension is infinitely variable and adjusts to body movement to prevent the feeling of falling backwards.

**Swivel-Tilt chair
with headrest
899 YJ A69 VP**

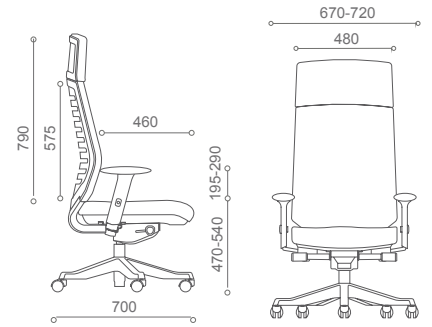

**Swivel-Tilt chair
898 YJ A69 VP**

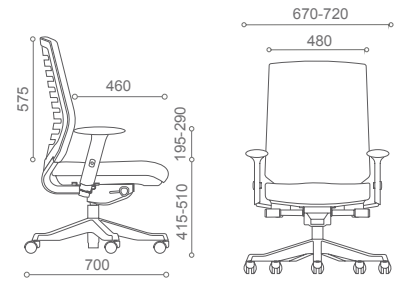

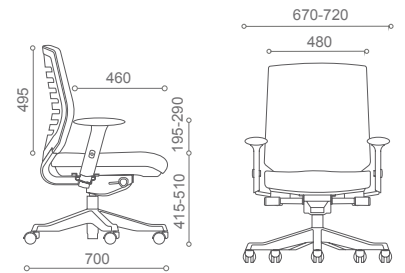

**Swivel-Tilt chair
897 YJ A69 VP**



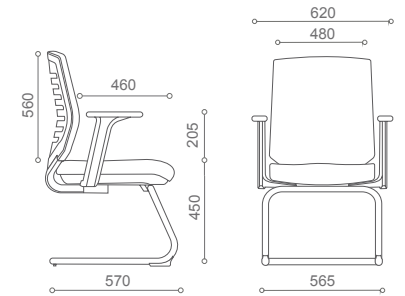
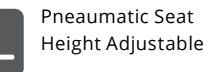

**Visitor chair
891 NA A37 B**



 Synchronized Mechanism

 Height - Width Adjustable Armrest

 Pneumatic Seat Height Adjustable

 Depth - Angle Adjustable Armpad
2-way adjustable armpad

Velo: Options

Armrest



4- Way Adjustable Armrest
with PU Ampad
(A69)



Fixed Armrest
(A37)

Base



350 Polished
Aluminium Base
(VP)



350 Studio Base
(N2)



Cantilever Base
(B)

HEAD OFFICE & FACTORY

Merryfair Chair System Sdn Bhd

(Co. No. 86276-A)
No.2, Jalan Koporat 1/KU9,
Taman Perindustrian Meru,
42200 Klang, Selangor D.E., Malaysia.

International Sales & Marketing

Tel. +603 3393 2888
Fax. +603 3393 2000
enquiry@merryfair.com

Domestic Sales & Marketing

Tel. +603 3393 6868
Fax. +603 3393 6888
domestic@merryfair.com

SHOWROOM OFFICE

Merryfair Marketing Sdn Bhd

(Co. No. 665054-V)
No. 82-84, Jalan 2/23A,
Jalan Genting Kelang,
53300 Kuala Lumpur, Malaysia.
Tel. +603 4149 8899
Fax. +603 4143 0113

REGIONAL OFFICE & SHOWROOM

美力菲 (中国) 家具有限公司

广东省佛山市顺德区容桂华口顺德高新区(容桂)华天路21号
邮编: 528306

Merryfair (China) Co.,Ltd
No. 21, Huatian Road, Shunde High Tech Industrial Zone
(Ronggui), Huakou Community, Ronggui Subdistrict,
Shunde District, Foshan City, Guangdong, China 528306.
Tel. +86 757 2636 9861
Fax. +86 757 2881 9700
domestic@merryfair.com.cn

Merryfair (Singapore) Pte Ltd

33 Ubi Avenue 3, #01-52/53 Vertex,
Singapore 408868.
Tel. +65 6284 9098
Fax. +65 6284 9028
enquiry@merryfair.com.sg

Merryfair (Thailand) Co.,Ltd

Thai Samut Building
Ground Floor, 163 Surawongse Road,
Bangrak, Bangkok 10500 Thailand.
Tel. +66 2266 3855
Fax. +66 2266 3859
sales@merryfair.co.th

